

آتور صنعت
ATOORSANAT

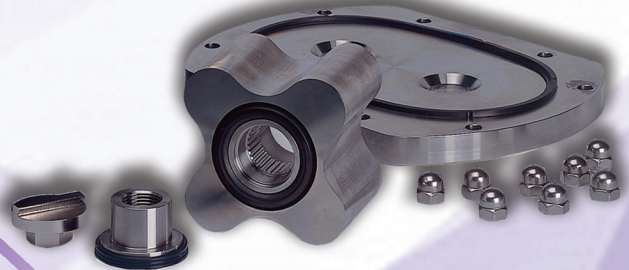

Pumps
Gear Motors
Electric Motors
Other Equipment & Parts

Product Profile 2021-2022 (Vol.1)

AtoorSanat is an Iranian industrial engineering company, founded in 2014. Over the next few years, we continued to expand, growing and investing in the business with a much bigger team and a greater selection of industrial equipment pieces including pumps, gear motors, electric motors, diesel generators, piping materials, electrical accessories, instrumentation, automation and a lot more that are listed in our profiles.

We've upgraded our system by adding a dedicated workshop for after-sales service and maintenance. Our number one goal is to make it easy for every customer to find exactly what they need to develop and maintain a successful business. That's why we have a team of technical experts who are ready and willing to help the customers by giving them advice on selecting the best items and equipment, according to their requirement. Built on a very simple concept that answering customers' questions makes the sale, we keep in touch with customers through direct contact via AtoorSanat website, phone calls, emails, and more importantly the international exhibitions.

We've worked hard to foster a unique company culture built on transparency, collaboration, and innovation. We pride ourselves on building diverse and inclusive teams that allow our employees to bring their authentic selves to work. We've built this culture not just because it works for our team members, but because it helps us provide the ultimate customer experience to everyone. A key element of our culture is the belief that education can improve our lives, which was why we decided to establish our Academy. Atoor Academy offers practice exercises, instructional videos, and personalized learning courses, workshops and seminars that empower learners to expand their knowledge and improve their business or upgrade their lives by obtaining new industrial skills.

Fortunately, our customers have trusted us for years and we are committed to making searching, ordering, and shipping as fast and seamless as possible for you and your business. We are proud to have supplied and serviced thousands of items for a large variety of different industries all over the world, including oil, gas and petrochemical, steel, cement, automotive, pharmaceutical, food, ceramic tiles and many more industries.

We believe that
Credibility is what lingers on

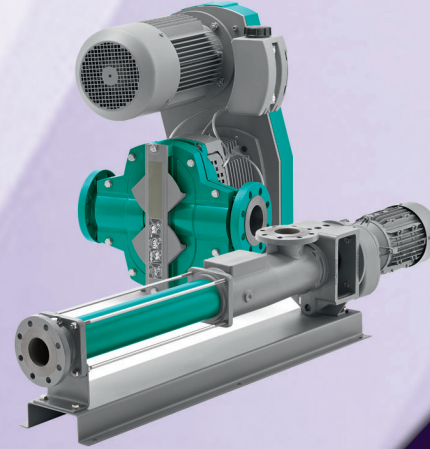

atoorsanat.com

@atoor.sanat

atoorsanat

+989120054403

info@atoorshop.com

+983132004



Motahari St . Isfahan . Iran



Services

We sell products, but it's not our only duty. Our more essential role is the after-sales service and support. In our workshops we service and repair all the products we offer, even in case that they were not supplied by us. We understand the significance of service in all industries and our vision is to offer you the best possible support at all times. Our qualified employees from the areas of applications and technical service will always be pleased to provide you with the best possible solutions. Our comprehensive service spectrum includes installation and commissioning, preventive maintenance, calibration service, on-site repair, technical information service, and spare parts. We are not satisfied until our customers are.

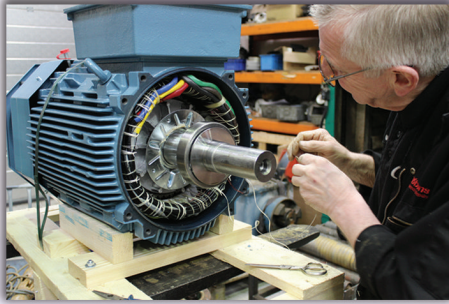

Wiring All Types of Electric Motors, Sewage, Submersible and Borehole Pumps

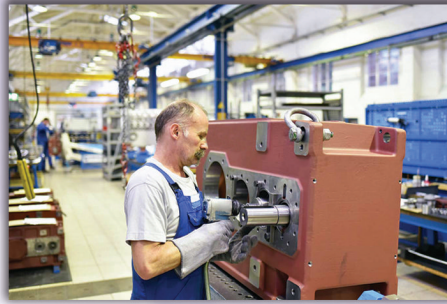

Gear Motors Repair and Maintenance



Domestic, Agricultural and Industrial Pumps Repair and Maintenance

Manufactures

Beside the products from well-known brands we offer, AtoorSanat manufactures some of industrial products on its own. They include some types of Teflon centrifugal acid pumps, high-pressure water pumps used in pools and hot tubs, sump pumps, progressive cavity pumps, centrifugal pumps for irrigation, and gear pumps.



Designed and Assembled Industrial Electrical Panelboards



Manufactured Teflon Centrifugal Acid Pumps

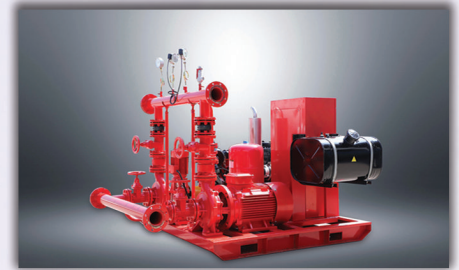

Designed and Assembled Water Pressure & Fire Fighting Booster Pumps

Our Profiles

- Vol. 1: Mechanical Equipment (Pumps, Gear Motors, Electric Motors, Generators, Side Channel Blowers, Vacuum Pumps, Vibrators, Fans and relevant parts)
- Vol. 2: Industrial Electrical Products, Instrumentation, and Automation
- Vol. 3: Piping Materials

Gear Motors



Planetary Gearbox

Used in drilling, hoists and cranes, pumps medical applications, robotics, conveyors, agriculture, appliances and aircrafts

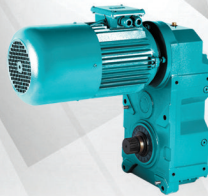

Shaft Mounted Gearbox

Used in belt conveyors, screw conveyors, material handling, winches and mixers



Worm Gearbox

Used in presses, mining, escalator and elevator drive systems, rolling mills, manufacturing and packaging industries, small machinery and conveyors



Variable Speed Gearbox

Used in steel rolling machines, textile, dyeing and plastic industries

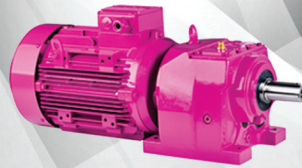

Helical Gearbox

Used in power industries, steel and rolling mills, food and plastic industries, elevators, conveyors, compressor, blowers, cutters and oil industries



Parallel Shaft Gearbox

Used in industrial cutters, winches, mills, extruders and heating units

Electric Motors



TEFC AC Motors



Servo Motors



Explosion Proof Motors

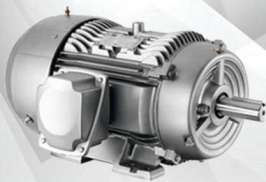

Dahlander Motors

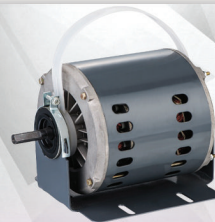

Air Cooler Electric Motors



Marine Motors

Pumps



Diaphragm Pump

Used for handling chemicals, oil, food pastes and slurry



Magnetic Acid Pump

Used for handling corrosive or toxic chemicals, acids and alkalis



Dosing / Metering Pump

Used for injecting liquids with accurate dose and flow rate in specific pressure



Borehole, Submersible and Sewage Pumps

Used in Wells or pools for irrigation or emptying the waste and septic tanks

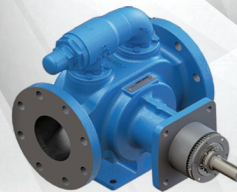

Gear Pump

Used for handling materials with high viscosity



Hot Oil Pump

Used for handling or circulating hot oil in different industries



Drum Pump

Used for emptying barrels of oil, liquid fuel, flammable and corrosive liquids



Peristaltic Pump

Used for handling chemicals and toxic liquids in medical, pharmaceutical and food industries



Piston Pump

Used in washing systems, hydrostatic tests and water jet cutters

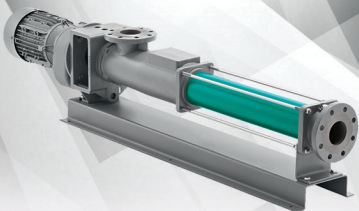

Progressive Cavity Pump

Used for handling thick liquids, media with abrasive particles and solids in oil and food industries



Booster Pump

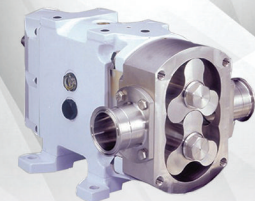

Lobe Pump

Used for handling high viscosity liquids, small diameter solids, hygienic, abrasive and shear sensitive liquids



Slurry Pump

Used for handling fluids with solids and abrasive particles



Multistage Pump

Used for feeding boilers, reverse, osmosis water supply boosting, irrigation fire fighting, heating/cooling conditioning and water circulation

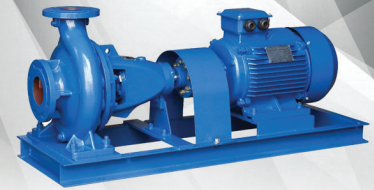

Centrifugal Pump

Used for boosting pressure in domestic and industrial utilizations



Gasoline & Diesel Engine Pumps

Used for irrigation in case electricity is not available



Circulator Pump

Used for circulating hot or cold water in heating and air-conditioning systems



Gasoline Generators

Used to generate electricity for domestic, commercial and industrial consumption

Other Equipment and Parts

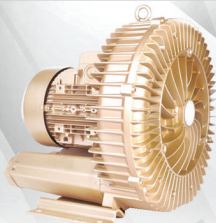

Side Channel Blowers

Used in soil remediation, central vacuum cleaning systems, pool air blowers and powder transfer



Mechanical Seals

Used for sealing rotating shafts in contact with fluids



Vibrators

Used in bowl feeders, vibratory feeders and vibrating hoppers in food, pharmaceutical and chemical industries



Vacuum Pump

Used in medical, pharmaceutical, wood, paper, sugar, chemical, packaging and food industries



Fans



Diesel Generators

Used to generate electricity in different industries